

Other Protistor® Fuses

Ferrule Fuses

22x58 gRC (URD) - 600 V to 690 VAC

EXTREMELY BREAKING CAPACITY RATING FUSES: PROTECTION OF SEMICONDUCTORS

IN COMPLIANCE WITH IEC STANDARD 60269.1 AND 4

600 - 690 V VOLTAGE RATING (CURRENT RATING 12 TO 135 A)
AS PER IEC 33

gR CLASS (CURRENT RATING 12 TO 100 A) ACCORDING TO VDE 636-23

- CLEARING ALL OVERLOADS
- IMPROVED SAFETY AND PROTECTION
- ENABLING SELECTIVE COORDINATION AMONG ALL DISTRIBUTION CIRCUIT FUSES

aR CLASS (CURRENT RATING 125 AND 135 A) AS PER VDE 636-23 AND IEC 60269.4

TWO MODELS COMPLYING WITH NF C 63210 AND 63211
WITH OR WITHOUT TRIP-INDICATOR

gRC FUSES ARE 700VAC-DC UL RECOGNIZED



Main Characteristics

Voltage rating U_N (V)	Class	Current rating I_N (A)	Pre-arcing $I^2t @ 1 \text{ ms}$ I^2_{tp} (A ² s)	Total clearing $I^2t @ U_N$ I^2_{tt} (A ² s)	Watts loss		Tested Breaking capacity	Estimated Breaking capacity
					$0.8 I_N$	I_N		
690	gRC	20	17	125	4.0	6.5	100k A @ 690 V	300k A @ 690 V
		25	39	280	4.5	7.5		
		32	72	490	5.0	9.0		
		40	118	785	5.5	10		
		50	242	1390	7.0	11.5		
		63	430	2460	8.0	13.5		
		80	970	5565	9.0	15.5		
100	2080	11950	10	17				
600	URD	125	2900	14000	14	22	100k A @ 600 V	300k A @ 600 V
		135	3360	17700	15	25		

Minimum operating voltage for the trip-indicator: 20 V

See Fuse Blocks and Fuse Holders section

Semiconductor (AC) fuses

Other Protistor® Fuses

Ferrule Fuses

22x58 gRC (URD) - 600 V to 690 VAC

22 X 58 Without trip-indicator

Current rating	Designation	Ref. Number	Catalog Number
12	6,900 CP gRC 22.58 12	F232719	FR22GC69V12
16	6,900 CP gRC 22.58 16	G232720	FR22GC69V16
20	6,900 CP gRC 22.58 20	C220940	FR22GC69V20
25	6,900 CP gRC 22.58 25	B220916	FR22GC69V25
32	6,900 CP gRC 22.58 32	A220915	FR22GC69V32
40	6,900 CP gRC 22.58 40	Z220914	FR22GC69V40
50	6,900 CP gRC 22.58 50	Y220913	FR22GC69V50
63	6,900 CP gRC 22.58 63	X220912	FR22GC69V63
80	6,900 CP gRC 22.58 80	Y220821	FR22GC69V80
100	6,900 CP gRC 22.58 100	W220911	FR22GC69V100

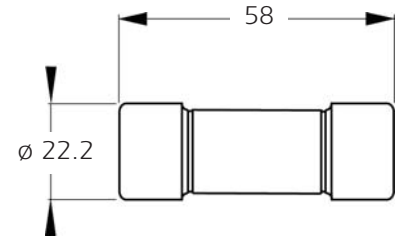

Weight: 57 g
Packaging: 10 pieces

22 X 58 With trip-indicator

20	6,921 CP gRC 22.58 20	D220734	FR22GC69V20T
25	6,921 CP gRC 22.58 25	G220921	FR22GC69V25T
32	6,921 CP gRC 22.58 32	F220920	FR22GC69V32T
40	6,921 CP gRC 22.58 40	E220919	FR22GC69V40T
50	6,921 CP gRC 22.58 50	D220918	FR22GC69V50T
63	6,921 CP gRC 22.58 63	C220733	FR22GC69V63T
80	6,921 CP gRC 22.58 80	X220820	FR22GC69V80T
100	6,921 CP gRC 22.58 100	C220917	FR22GC69V100T
125	621 CP URD 22.58 125	A220708	FR22UD60V125T
135	621 CP URD 22.58 135	B220709	FR22UD60V135T

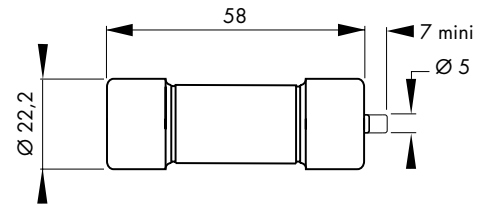

Weight: 57 g
Packaging: 10 pieces



except 125 and 135A rating

Electrical characteristics

Time vs current characteristics

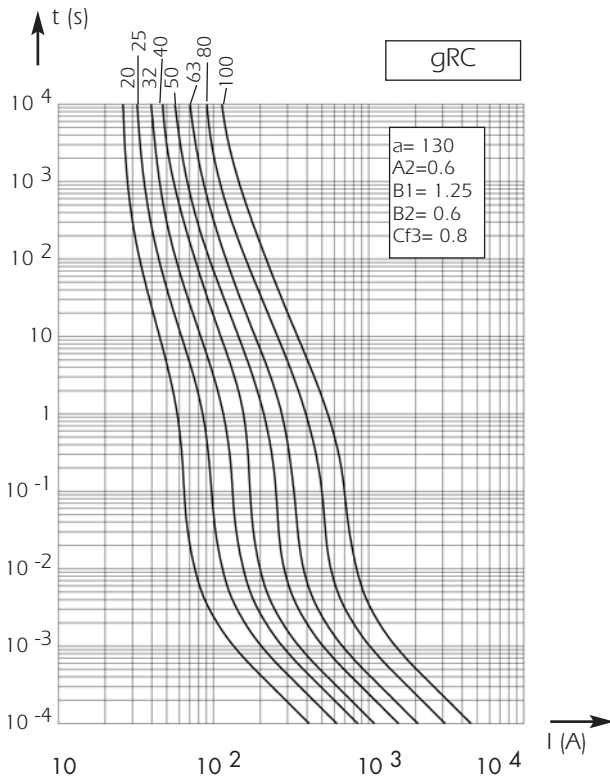

These curves indicate, for each rated current, pre-arcing time vs. R.M.S. pre-arcing current

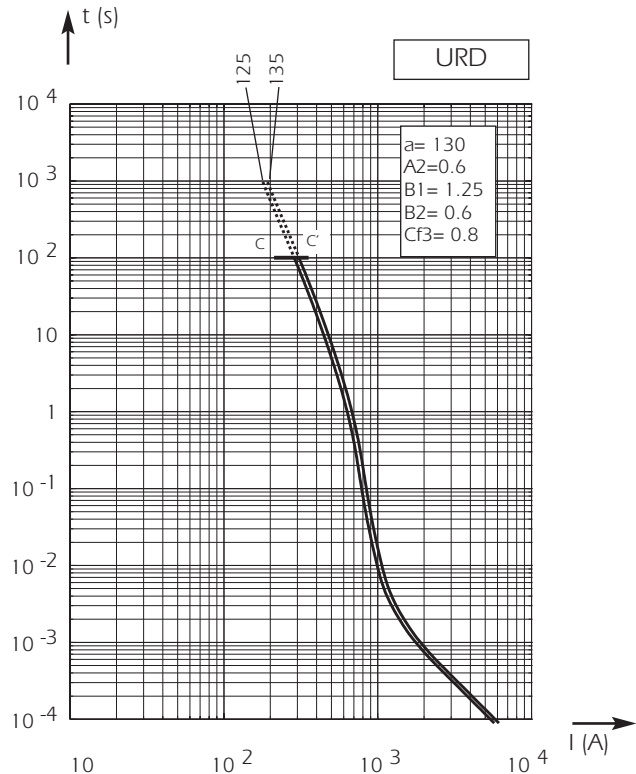

Tolerance for mean pre-arcing current $\pm 9\%$ for all current ratings

Other Protistor® Fuses Ferrule Fuses 22x58 gRC (URD) - 600 V to 690 VAC

Total clearing I²t

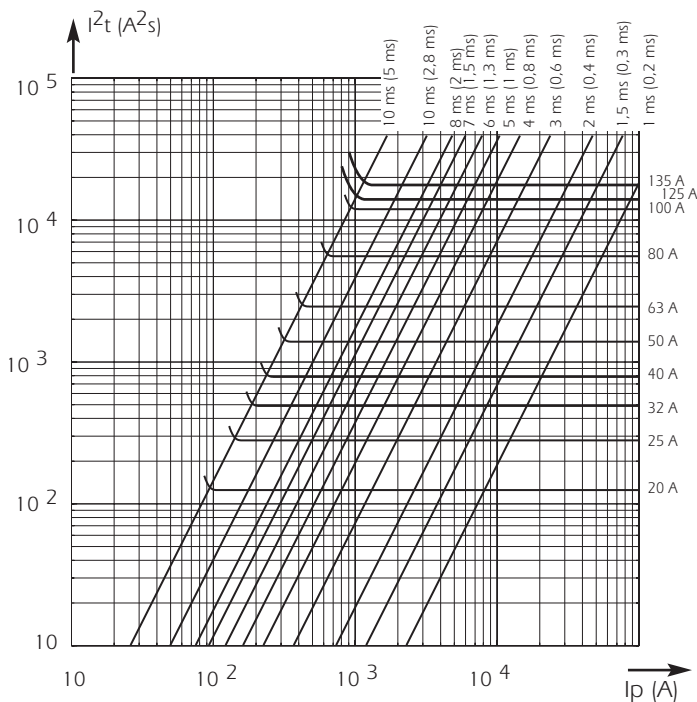

Above: Horizontal curves show, for each rated current, maximum values of total clearing I^2t (I^2t_t) as a function of prospective current I_p @ 690 V. $\cos\phi = 0.15$ (125-135 A @ 600 V. $\cos\phi = 0.15$)
Oblique lines indicate total clearing duration T_t with associated pre-arcing duration in brackets.

I²t corrective factor

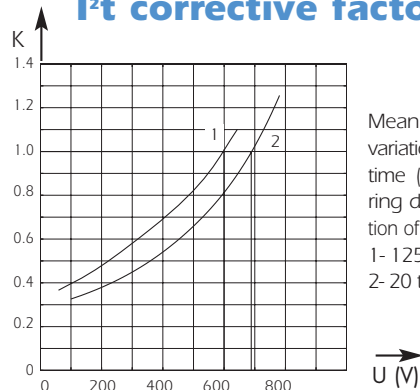

Mean curves showing variation of total clearing time (I^2t_t) and total clearing duration T_t as a function of operating voltage U .
1- 125 and 135 A rating
2- 20 to 100 A rating

Peak arc voltage

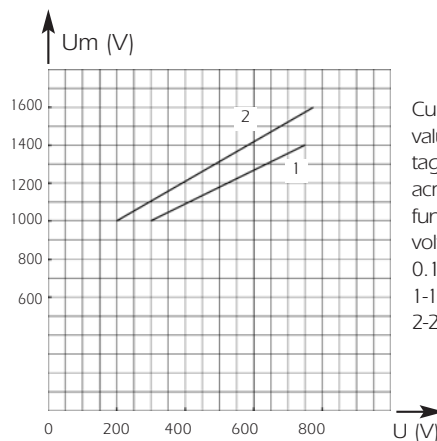

Curve showing peak value U_m of arc voltage which appears across fuse-link as a function of operating voltage U @ $\cos\phi = 0.15$
1-125 and 135A rating
2-20 to 100A rating

Current limitation curves

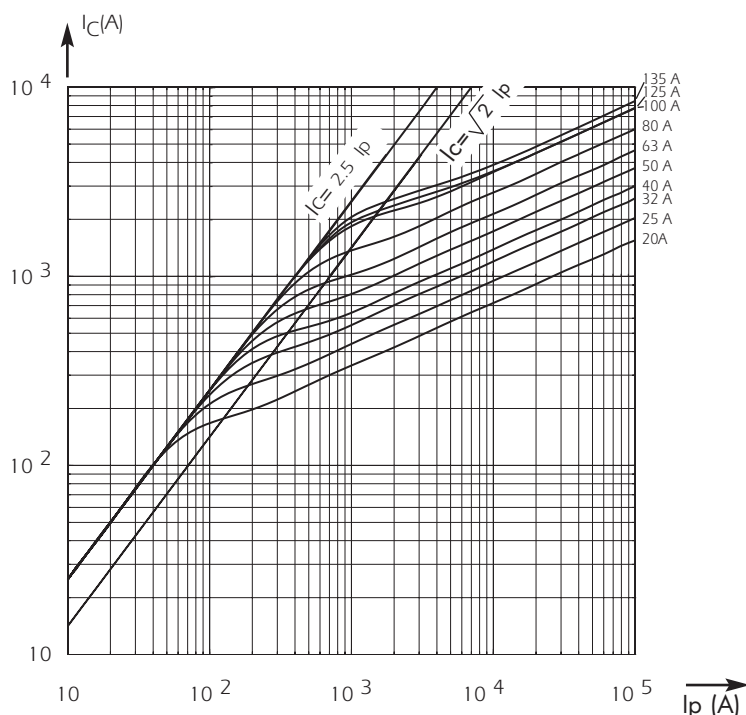

Left: Curves show value of peak let-through current I_c as a function of the available fault current I_p .

Semiconductor (AC) fuses

Other Protistor® Fuses

Ferrule Fuses

22x58 gRC (URD) - 600 V to 690 VAC

DC Application data

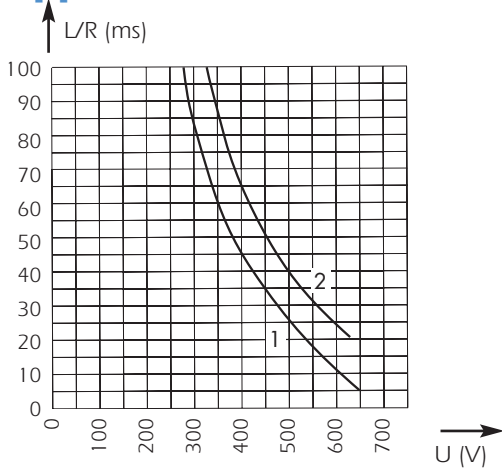

Ces courbes indiquent la constante de temps L/R maximale admissible en fonction de la tension d'utilisation

Courbe 1 : $I_p \geq 1,6 I_n$ pour fusibles gRC uniquement (calibres de 12 à 100 A)

Courbe 2 : $I_p \geq 2,5 I_n$ pour fusibles gRC et URD

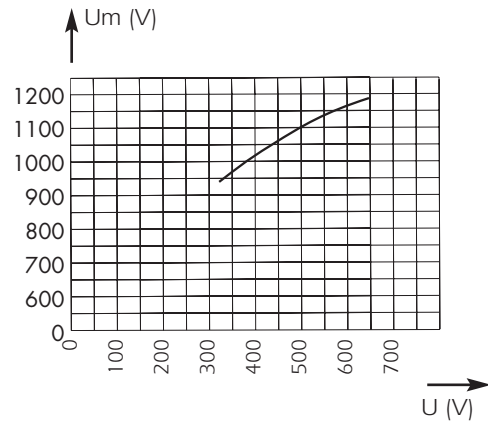

Above: Curve indicates peak arc voltage U_m which may appear across fuse terminals at working voltage U.

NEW gR-CLASS

OPTIMAL PROTECTION OF POWER EQUIPMENT

Thanks to recent technological developments, Ferraz Shawmut today markets gR-class PROTISTOR® fuses capable of clearing all types of overloads, from low multiples of current ratings up to very high short-circuit currents. Enhanced performance enables these fuses to provide solutions to many previously unsolved problems in power electronics: protection of cables without the use of additional components, protection of equipment from fire hazards, selective coordination of different fuses within a single power distribution installation...

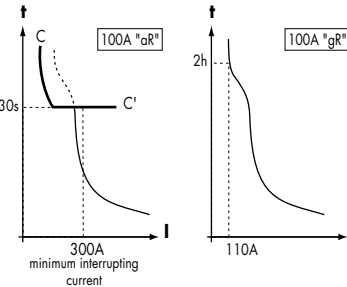

Example:
100A aR vs. 100A gR

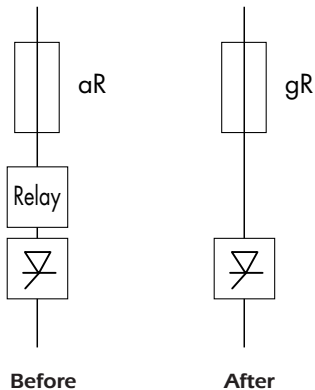

SELECTIVE COORDINATION

gR-class semiconductor fuses can be utilized in association with gI and gG-class low voltage power distribution fuses of the same current rating, installed upstream. In a "selectively coordinated" distribution installation, melting is limited to the fuse associated with the faulted circuit, while upstream fuses remain intact. This prevents unnecessary down-time due to power blackouts in non-faulted branches.

Example of
selective
coordination

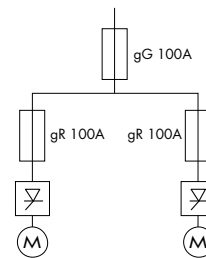

aR-CLASS vs. gR-CLASS

aR-class fuses feature a high minimum interrupting current as compared with their current rating. The primary time-current characteristic of aR-class fuses is the CC' curve, above which another protection device must be associated. The gR-class fuse represents considerably improved performance in semiconductor protection

FERRAZ SHAWMUT EXPERTISE

gR-class fuses should be used in the design of low voltage equipment and in the protection of power electronics equipment. Designers can often substitute a gR-class fuse for an aR-class fuse (10x38, 14x51, 22x58, PSC 000 and 17x49 DIN80 or BS 88-4) but the reverse is not true: an aR fuse can never replace a gR fuse. Start protecting your new equipment with gR-class fuses today. The application of gR class fuses, with current ratings less than 100 Amps, offers enhanced protection, safety and reliability, along with reduced risk of replacement errors and assembly costs.